

# Inductive sensor NRB20-L3-E2-IO-V1

- 20 mm flush
- Reduction factor = 1
- Magnetic field resistant
- IO-Link interface for service and process data
- Switch point mode or window mode can be set
- Switching function, stability alarm and pulse extension can be set
- 4-way LED indicator
- Quick mounting bracket



## Function

Reduction factor 1 sensors reliably detect different metals with the same switch state. The integrated IO-Link interface enables clear identification of the sensor and diagnosis of the sensor condition. When using the sensor, parameters and operating modes can be optimally configured specifically for the intended application. In addition to setting the switching function and a pulse extension, the user can select either switch point mode or window mode in combination with a stability alarm. In switch point mode, the stability alarm signals the detection of an object in the area between the assured operating distance and operating distance  $s_n$ . In window mode, it signals the detection of an object below the window between operating distance  $s_n$  and the nearest operating distance. A stability alarm is displayed to the user via a flashing LED and process data.

## Dimensions

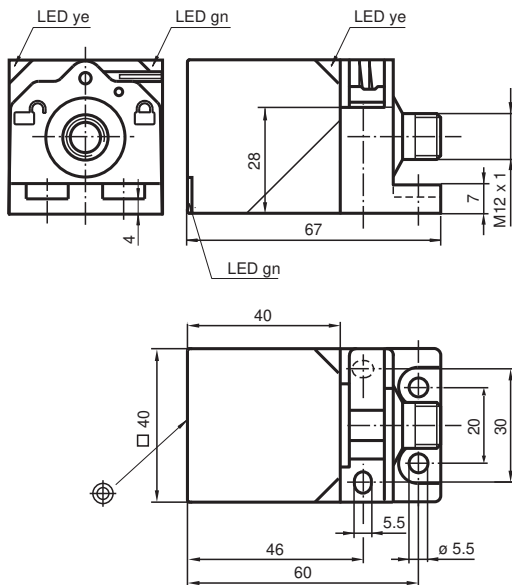

## Technical Data

General specifications	
Switching function	Normally open/closed (NO/NC) programmable
Output type	PNP
Rated operating distance	$s_n$ 20 mm (factory setting)
Near operating distance	15 mm (can be activated by software)
Installation	flush
Output polarity	DC

Release date: 2022-05-30 Date of issue: 2022-05-30 Filename: 306534-0003\_eng.pdf

## Technical Data

Assured operating distance	$s_a$	0 ... 16.2 mm
Reduction factor $r_{Al}$		1
Reduction factor $r_{Cu}$		1
Reduction factor $r_{304}$		1
Reduction factor $r_{316L}$		1
Output type		3-wire
<b>Nominal ratings</b>		
Operating voltage	$U_B$	10 ... 30 V DC
Switching frequency	$f$	0 ... 440 Hz (switch point mode) 0 ... 10 Hz (window mode, switch point mode with stability alarm)
Hysteresis	$H$	typ. 3 %
Reverse polarity protection		reverse polarity protected
Short-circuit protection		pulsing
Voltage drop	$U_d$	≤ 0.5 V
Operating current	$I_L$	0 ... 200 mA
Off-state current	$I_r$	0 ... 0.5 mA typ. 60 μA at 25 °C
No-load supply current	$I_0$	≤ 20 mA
Time delay before availability	$t_v$	max. 150 ms
Constant magnetic field	$B$	200 mT
Alternating magnetic field	$B$	200 mT
Operating voltage indicator		LED, green
Status indicator		LED, yellow
<b>Functional safety related parameters</b>		
MTTF <sub>d</sub>		701 a
Mission Time ( $T_M$ )		20 a
Diagnostic Coverage (DC)		0 %
<b>Interface</b>		
Interface type		IO-Link ( via C/Q = pin 4 )
IO-Link revision		1.1
Device ID		0x201001 (2101249)
Transfer rate		COM2 (38.4 kBaud)
Min. cycle time		2.3 ms
Process data width		Process data input (control system side): 2 Bit Process data output (control system side): none
SIO mode support		yes
Compatible master port type		A
<b>Compliance with standards and directives</b>		
Standard conformity		
Standards		EN 60947-5-2:2007 EN 60947-5-2/A1:2012 IEC 60947-5-2:2007 IEC 60947-5-2 AMD 1:2012
<b>Approvals and certificates</b>		
Protection class		II
Rated insulation voltage	$U_i$	60 V
Rated impulse withstand voltage	$U_{imp}$	800 V
UL approval		cULus Listed, General Purpose Class 2 power source
CCC approval		CCC approval / marking not required for products rated ≤36 V
<b>Ambient conditions</b>		
Ambient temperature		-25 ... 70 °C (-13 ... 158 °F)
Storage temperature		-40 ... 85 °C (-40 ... 185 °F)
<b>Mechanical specifications</b>		
Connection type		Connector plug M12 x 1 , 4-pin
Housing material		GD-ZnAl4Cu1, coated mounting flange PA6-GF35

Release date: 2022-05-30 Date of issue: 2022-05-30 Filename: 306534-0003\_eng.pdf

Refer to "General Notes Relating to Pepperl+Fuchs Product Information".

Pepperl+Fuchs Group  
www.pepperl-fuchs.comUSA: +1 330 486 0001  
fa-info@us.pepperl-fuchs.comGermany: +49 621 776 1111  
fa-info@de.pepperl-fuchs.comSingapore: +65 6779 9091  
fa-info@sg.pepperl-fuchs.com

**PEPPERL+FUCHS**

**Technical Data**

Sensing face	PA 6 Grivory GVN-35H
Degree of protection	IP67
Mass	205 g
<b>Factory settings</b>	
Default setting	operating mode = switch point mode with stability alarm switching function = Normally open (NO) switching distance = 20 mm

**Connection**

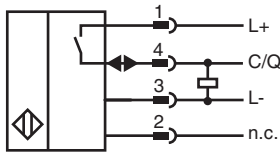

**Connection Assignment**

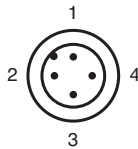

Wire colors in accordance with EN 60947-5-2

- 1 | BN (brown)
- 2 | WH (white)
- 3 | BU (blue)
- 4 | BK (black)

Release date: 2022-05-30 Date of issue: 2022-05-30 Filename: 306534-0003\_eng.pdf

## Function Principle

### Switching output modes

#### Switch point mode at rated operating distance $s_n$

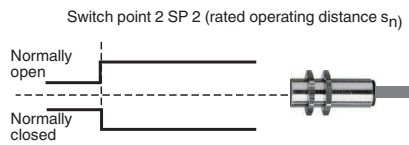

#### Switch point mode with near operating distance

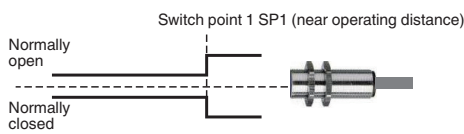

#### Window mode

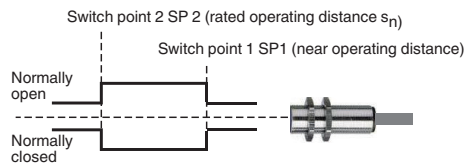

### Stability alarm

#### Switch point mode with stability alarm (factory default)

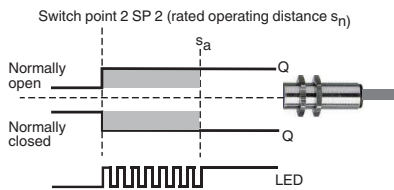

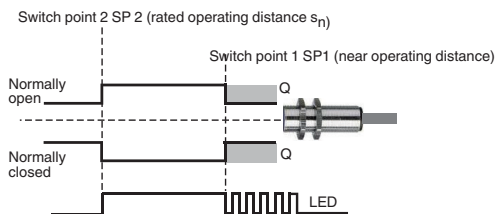

#### Window mode with stability alarm















Release date: 2022-05-30 Date of issue: 2022-05-30 Filename: 306534-0003\_eng.pdf

## Accessories

	<b>V1-G-2M-PVC</b>	Female cordset single-ended M12 straight A-coded, 4-pin, PVC cable grey
	<b>V1-W-2M-PVC</b>	Female cordset, M12, 4-pin, PVC cable

**Accessories**

	<b>MHW 01</b>	Modular mounting bracket
	<b>MH 02-L</b>	Mounting aid for VariKont-L
	<b>MH 04-2681F</b>	Mounting aid for VariKont, +U1+ and +U9*
	<b>ICE2-8IOL-G65L-V1D</b>	EtherNet/IP IO-Link master with 8 inputs/outputs
	<b>ICE3-8IOL-G65L-V1D</b>	PROFINET IO IO-Link master with 8 inputs/outputs
	<b>ICE2-8IOL-K45S-RJ45</b>	EtherNet/IP IO-Link master with 8 inputs/outputs, DIN rail, screw terminal
	<b>ICE3-8IOL-K45P-RJ45</b>	PROFINET IO IO-Link master with 8 inputs/outputs, DIN rail, push-in terminals
	<b>ICE3-8IOL-K45S-RJ45</b>	PROFINET IO IO-Link master with 8 inputs/outputs, DIN rail, screw terminal
	<b>IO-Link-Master02-USB</b>	IO-Link master, supply via USB port or separate power supply, LED indicators, M12 plug for sensor connection
	<b>ICE1-8IOL-G30L-V1D</b>	Ethernet IO-Link module with 8 inputs/outputs
	<b>ICE1-8IOL-G60L-V1D</b>	Ethernet IO-Link module with 8 inputs/outputs
	<b>ICE2-8IOL-K45P-RJ45</b>	EtherNet/IP IO-Link master with 8 inputs/outputs, DIN rail, push-in connectors

Release date: 2022-05-30 Date of issue: 2022-05-30 Filename: 306534-0003\_eng.pdf

Refer to "General Notes Relating to Pepperl+Fuchs Product Information".